

HAMEG

Instruments

MANUAL

Oscilloscope HM 605

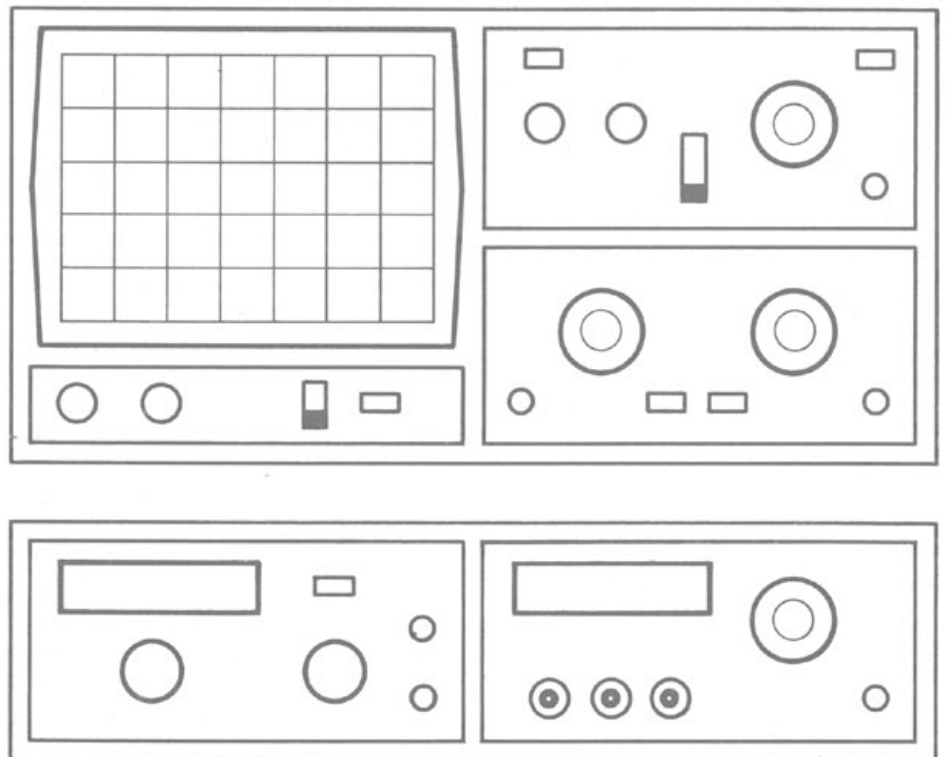

Technical Data	P 1
Accessories	Z 1
General Information	
Operating Conditions	M 1
Use of tilt handle	M 1
Care and maintenance	M 1
Warranty	M 2
Front Panel Elements	
Folder with Front View	M20,21
Operating Instructions	
Mains/Line Voltage change	M 3
Switching on and setting up	M 3
Trace alignment	M 4
Signal displays	M 4
Connection of test signal	M 4
High frequency signals	M 5
The vertical axis	M 5
Y amplifiers and attenuators	M 6
Modes of channel operation	M 6
Selection of operating mode	M 6
Overscan indication	M 6
Probe adjustment	M 7
Amplitude measurement	M 7
AC/DC measurements	M 8
Differential measurements	M 9
The horizontal axis	M 9
The timebase	M 9
Timebase triggering	M10
Trigger controls	M11
Trigger coupling	M11
Hold-off control	M12
Sweep Delay	M12
Operation of DELAY facility	M13
Time and frequency measurement	M14
Measurement of risetime	M15
CRT beam modulation	M16
Timebase signal output	M17
Y output	M17
Component Tester	M17
Test patterns (Component Tester)	M20
Performance Tests	
Test equipment	T 1
Intensity and focus	T 1
Astigmatism	T 1
Trace alignment	T 1
Internal power supply check	T 2
Vertical axis	T 2
Vertical amplifier symmetry and drift	T 3
Vertical channel calibration	T 4
Frequency response	T 4
Frequency compensation of Y-input attenuators	T 4

Oscilloscope HM 605

Vertical amplifier output	T 5
Timebase calibration	T 5
Hold-off check	T 6
Trigger checks	T 6
Trigger coupling checks	T 7
Sweep delay	T 7
Trace expansion check	T 8
Z-modulation	T 8
Component Tester check	T 8

Circuit Diagrams

Block Diagram	D 1
Identification of electrical Components	D 2
Y-Input, Attenuator and Y-Preamplifier Ch.I and Ch.II	D 3
Y-Intermediate Amplifier, Channel Flip-Flop, Gates, Chopper Generator	D 4
Components Locations Y-Board	D 5
Y-Final Amplifier, Overscan Circuit, Calibrator, Component Locations YF and Y01	D 6
Trigger Circuit, Delay Circuit	D 7
Timebase Circuit, X-Final Amplifier	D 8
Component Locations TB-Board	D 9
Power Supply	D10
CRT-Circuit, Unblanking Circuit, HV-Supply	D11
Component Locations: Z-, Cal-, Delay-, TR-Board	D12

Adjusting Plan	A 1
---------------------------------	-----

Specification

Operating Modes

Channel I, Channel II, Channel I and II alternate or chopped (chop frequency ≈ 0.5 MHz).
sum or difference Ch.II \pm Ch.I (with Ch.I INV. button)
X-Y mode: same sensitivity in both directions.

Vertical Deflection (Y)

Bandwidth of both channels
DC to 60 MHz (-3 dB), DC to 85 MHz (-6 dB).
Risetime: ≈ 5.8 ns. Overshoot: max. 1%.
Deflection coefficients: 12 calibrated steps,
5 mV/cm to 20 V/cm in 1-2-5 sequence,
with variable control 2.5:1 up to at least 50 V/cm.
Accuracy in calibrated position: $\pm 3\%$.
Y-Magnification x5 calibrated to **1 mV/cm**,
bandwidth: DC to 5 MHz (-3 dB).
Input impedance: 1 M Ω || 30 pF.
Input coupling: DC-AC-GND.
Input voltage: max. 400V (DC + peak AC).
Y-Output from Ch.I or Ch.II: ≈ 45 mV/cm into 50 Ω .
Y-Overscanning indication: with 2 LEDs.
Delay line: to view leading trigger edge.

Timebase

Time coefficients: 23 calibrated steps,
50 ns/cm to 1 s/cm in 1-2-5 sequence,
with variable control 2.5:1 to at least 2.5 s/cm,
with **X-Magnification x10** ($\pm 5\%$) to **5 ns/cm**.
Accuracy in calibrated position: $\pm 3\%$.
Hold-off time: variable control 10:1.
Ramp output: approx. 5V (on rear panel).
Trigger system: Automatic (peak-to-peak value)
or Normal Trig. LED indication for trig. action.
Single sweep: Single-Reset buttons with LED ind.
Slope: positive or negative.
Sources: Ch. I, Ch. II, alternate Ch. I/II, line, external.
Coupling: AC-DC-HF-LF (TV frame).
Threshold: internal 5mm, external 50mV.
Bandwidth: DC to at least 80 MHz.
Sweep delay: 7 decade steps, 100 ns to 0.1 s,
with variable fine control, approx. 10:1 to 1 s.
Modes: Search, Delay. With LED indication.

Horizontal Deflection (X)

Bandwidth: DC to 5 MHz (-3 dB).
Input: via Ch. II (see Y deflection spec.).
X-Y phase shift: $< 3^\circ$ up to 120 kHz.

Component Tester

Test voltage: max. 8.5V rms (open circuit).
Test current: max. 24mA rms (shorted).
Test frequency: 50 or 60 Hz (line frequency).
One test lead is grounded (Safety Earth).

General Information

Cathode-ray tube: D14-370 P31/113R,
P7/113R optional (long decay characteristic),
internal graticule **8 x 10 cm**.
Total accelerating potential: approx. 15 kV.
Graticule illumination: three-position switch.
Trace rotation: adjustable on front panel.
Z-Modulation input: positive TTL level = bright.
Calibrator: square-wave generator, ≈ 1 kHz/1 MHz
switchable, risetime < 5 ns, for probe compensation,
output voltages: 0.2V and 2V $\pm 1\%$.
Regulated DC power supplies: all voltages.
Protective system: Safety Class I (IEC 348).
Line voltages: 110, 125, 220, 240V AC.
Permissible line fluctuation: $\pm 10\%$.
Line frequency range: 50 to 400 Hz.
Power consumption: approx. 43 Watts.
Weight: approx. 7.5 kg. Color: techno-brown.
Cabinet (mm): **W** 285, **H** 145, **D** 380.
Lockable tilt handle.

Subject to change.

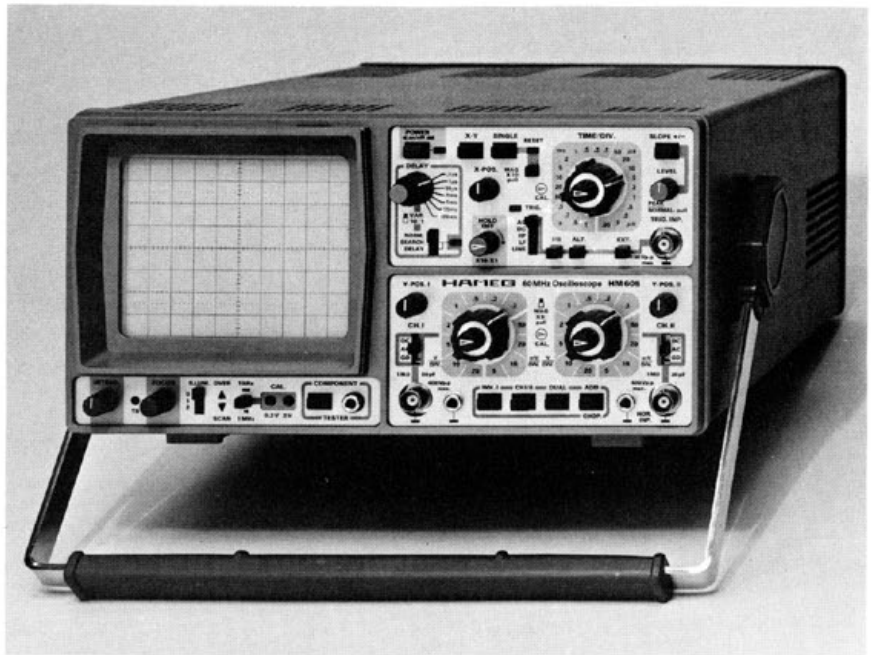

60 MHz Multifunction Oscilloscope

Y: 2 channels, DC-60 MHz, max. 1 mV/cm, delay line;
X: 2.5 s/cm-5 ns/cm incl. x10 magnification, delayed sweep;
triggering up to 80 MHz; var. hold-off time; Component Tester.

The new **HM605** is a truly **versatile scope** satisfying a wide variety of exacting requirements in **laboratory, production, and service**. The maximum input sensitivity of **1 mV/div.** facilitates the display of extremely low-level signals. Despite their high sensitivity, the HM605's vertical amplifiers are of **excellent stability** and **low drift** design with not more than 1% overshoot.

The built-in **delay line** permits viewing of the trigger edge at all times. The **overscan feature** indicates if any part of the trace passes the vertical limits of the CRT screen. An **analog Y-output**, switchable to Channel I or II, allows further processing of the signal.

Reliable triggering is ensured up to at least **80 MHz**, and trigger facilities include vertical mode **alternate triggering**, line trigger and single sweep operation. Other trigger features are **variable hold-off time**, RF- and LF-filters at any sweep speed for TV frame and line displays, as well as normal and **automatic peak-value triggering**. An LED indicates when the sweep is triggered. Sweep ranges from **5 ns/div.** to **2.5 s/div.** ensure optimum resolution of slow and fast signals. The **variable sweep delay** facility enables any section of the waveform to be expanded by **1000** and more for detailed signal analysis. A rectangular **14 kV CRT** with illuminated graticule provides exceptionally bright and sharp displays.

A **unique feature** for scopes in this price range is the built-in **switchable 1 kHz/1 MHz squarewave generator** providing **0.2V** and **2V** calibration signals with a risetime < 5 ns. It is now possible to self-test instantly the transient response of the vertical amplifiers and compensation of **modular attenuation probes** for utilization of the **full bandwidth of scope and probe**.

A **Component Tester** is also incorporated. The HM605's **outstanding price/performance capability** is not likely to be matched by similar products in the near future.

Accessories optional

Probes: 1X, 10X, 10X(HF), 100X, 1X/10X; demodulating probe;
test cables BNC-BNC and banana-BNC; 50 Ω BNC termination;
4-Channel Amplifier; viewing hood; carrying case; etc.

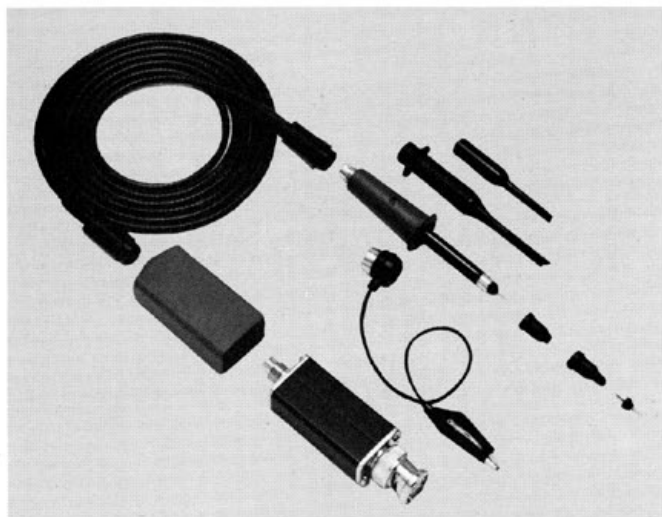

Modular Probes

The clear advantage over ordinary probes are field replaceable parts and the **HF-compensation feature** on the 10:1 attenuator probes. For the first time, probes in this price range allow adjustments of their HF-characteristics to match individually the input impedance of each scope. This is particularly important for scopes with higher bandwidths (>50MHz), as otherwise strong overshoot or rounding may occur, when measuring fast-rising square-waves. An exact HF-compensation, however, is only possible with square-wave generators having a risetime <5ns. The HM204-2, HM208 and HM605 already feature such a calibration generator. For other oscilloscopes, it is available as accessory item HZ60. At present the following Modular Probes are available:

Type	HZ50	HZ51	HZ52	HZ53	HZ54 selectable
Attenuation Ratio	1:1	10:1	10:1 (HF)	100:1	1:1 / 10:1
Bandwidth min. (MHz)	30	150	250	150	10 / 150
Risetime (ns)	11	<2	<1.4	<2	35 / <2
Inp. Capacitance (pF)	45	16	16	6.5	40 / 18
Inp. Resistance (MΩ)	1	10	10	100	1 / 10
Inp. Voltage max. (V _p)	600	600	600	1200	600
Cable Length (m)	1.2	1.2	1.5	1.5	1.2

Demodulator Probe

HZ55

Special probe for AM-demodulation and wobbulator measurements. HF-Bandwidth 100kHz - 500MHz (±1dB). AC Input Voltage 250mV - 50V_{rms}. DC Isolation Voltage 200V DC including peak AC. Cable length 1.2m.

Conventional Probes

These popular standard probes are well suited for all oscilloscopes up to 50MHz bandwidth.

Type	HZ30	HZ35	HZ36 selectable
Attenuation Ratio	10:1	1:1	1:1 / 10:1
Bandwidth min. (MHz)	100	10	10 / 100
Risetime (ns)	3.5	35	35 / 3.5
Inp. Capacitance (pF)	13	47	47 / 13
Inp. Resistance (MΩ)	10	1	1 / 10
Inp. Voltage max. (V _p)	600	600	600
Cable Length (m)	1.5	1.5	1.5

Test Cable – 4mm Banana

HZ32

Coaxial test cable; length 1.15m, characteristic impedance 50Ω, cable capacitance 120pF. Input voltage max. 500V_p.

Test Cable BNC-BNC

HZ34

Coaxial test cable; length 1.2m, characteristic impedance 50Ω, cable capacitance 126pF. Input voltage max. 500V_p.

Adapter 4mm Banana to BNC

HZ20

Two 4mm binding posts (19mm between centers) to standard BNC male plus. Input voltage max. 500V_p.

50Ω Through-Termination

HZ22

For terminating systems with 50Ω characteristic impedance. Maximum load 2W. Max. voltage 10V_{rms}.

Carrying Cases

For HM203 and HM203-3	HZ42
For HM312, HM412, HM512, and HM705	HZ43
For HM307, HZ62, and HZ64	HZ44
For HM103	HZ45
For HM203-4, HM203-5, HM204, HM204-2 HM208 and HM605	HZ46

Viewing Hoods

HZ47

For HM203, HM204, HM208, HM605, HM705, HM808, HM312, HM412, HM512, and HM812

Scope Tester

HZ60

For checking the Y amplifier, timebase, and compensation of all probes, the HZ60 provides a crystal-controlled, fast-rising (typ. 3ns) square-wave generator with switchable frequencies of 1, 10, 100kHz, and 1MHz. Three BNC outputs provide signals of 25mV_{pp} into 50Ω, 0.25V_{pp} and 2.5V_{pp} (open circuit for 10X and 100X probes); accuracy ±1%. Battery-powered or AC supply operated (optional).

Component Tester

HZ65

Indispensable for trouble-shooting in electronic circuits. Single component and in-circuit tests are both possible. The HZ65 operates with all scopes, which can be switched to X-Y operation (ext. horizontal deflection). Non-destructive tests can be carried out on almost all semiconductors, resistors, capacitors, and coils. Two sockets provide for quick testing of the 3 junction areas in any small power transistor. Other components are connected by using 2 banana jacks. Test leads supplied.

Examples of Test Displays

Short circuit Capacitor 33μF Junction E-C Z-diode <8V



General Information

This instrument is designed and tested according to international safety standards (IEC 348) and has left the factory in a perfectly safe condition. To preserve this state and to ensure operation without danger, the user must observe all advice and warning notices given in this manual and which are marked on the instrument.

The case, chassis and all measuring terminals are connected to the safety earth conductor (ground). The instrument operates according to Safety Class I (three-conductor AC power cable). The grounded accessible metal parts (case, sockets, jacks) and the power line circuit of the HM605 have been tested for insulation breakdown with 1500V/50Hz.

Under certain conditions, 50Hz or 60Hz hum voltages can occur in the measuring circuit due to the interconnection with other line powered equipment or instruments. This can be avoided by using an isolation transformer between the line outlet socket and the power plug of the HM605.

Without an isolation transformer, the instrument's power cable must be connected with an approved three-pin electrical supply plug (line, neutral, ground), which meets the International Electrotechnical Commission (IEC) safety standards. The safety ground connector must always be connected.

When displaying waveforms where the "low level" side of the signal is at a high potential, even with the use of a protective isolation transformer, it should be noted that this potential is connected to the oscilloscope's case and other accessible parts.

High voltages are dangerous. In this case, special safety precautions must be taken, which must be supervised by qualified personnel.

Operator's safety

Most cathode ray tubes develop X-rays, but with the HM605, the dose equivalent rate falls far below the maximum permissible value of 36pA/kg (0.5mR/h).

Operating Conditions

The permissible ambient temperature range during operation is +10 °C...+40 °C. The permissible ambient temperature range for storage or transportation is -40 °C...+70 °C.

If condensed water exists in the instrument it should be acclimatized before switching on. In some cases (e.g. extremely cold oscilloscope) two hours should be allowed before the instrument is put into operation. The instrument should be kept in a clean and dry room and must not be operated in explosive, corrosive, dusty, or moist environments. The oscilloscope can be operated in any position,

but the convection cooling must not be impaired. For continuous operation the instrument should be used in the horizontal position, preferably tilted upwards, resting on the tilt handle.

Use of tilt handle

The handle of the oscilloscope can be fixed in four positions, two for use as a carrying handle and two positions as a tilt stand.

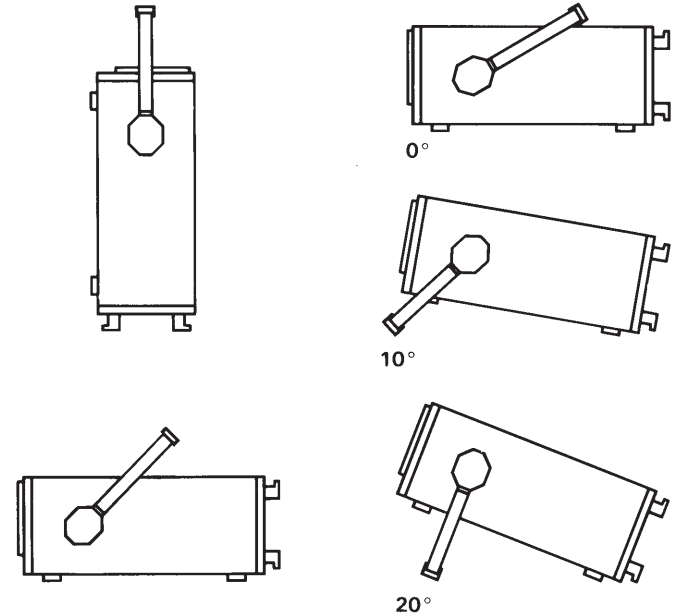

Handle in carrying positions

Care and maintenance

The HM605 Oscilloscope was designed, manufactured and tested by HAMEG to meet the highest standards of technology.

It is important, however, that the oscilloscope is kept in a condition that can offer long and reliable operation.

Please follow the simple hints given below to ensure long and reliable operation of the HAMEG HM605.

Care – in use

- Operate the oscilloscope on correct mains supply.
- When in operation, the oscilloscope should be stood on its tilt handle so that maximum convection cooling is possible.
- Switching the oscilloscope **ON** and **OFF** at short intervals of time stresses the cathode of the CRT and should therefore be avoided.
- To reduce risk of damage to the CRT's fluorescent screen, the intensity setting should be set at the minimum usable level. **Particular care is required when a single spot is displayed.**
- Store all oscilloscope accessories in a safe place and

-
- keep them in good condition.
- Make regular performance tests.
(See section 4, HM 605 Performance Tests)

Cleaning

Keep the oscilloscope free from dust and dirt. Dust front panel and case with a camel hair brush or a lint free cloth.

Do not use any solvents. Use only water with a fine soap and soft cloth, if cleaning is required. Never apply water directly.

Clean the CRT screen as often as possible with a damp cloth.

Storage

Store the oscilloscope in a clean, dry area of moderate temperature. Cover the instrument with a suitable cloth or replace it in the original carton to prevent deposits of dust.

Warranty

Before shipment, each oscilloscope passes a 10-hour quality control test.

HAMEG warrants all its instruments against defects in workmanship and materials for a period of two years from the date of purchase. This warranty is only valid where there is no damage caused by accidents, negligence, mis-application, or repairs or modification attempted by any person other than an authorized **HAMEG** dealer. This warranty is only valid with the original purchaser. **HAMEG** is not liable for consequential damages.

In the event that any fault does occur during the warranty period, the instrument should be returned in the original packing, post paid, and must be accompanied by a brief description of the problem encountered and date and place of purchase.

To ensure rapid service, please attach a clearly written tag showing name, department, address and telephone number to where the instrument has to be returned.

HAMEG service support

HAMEG offers an extensive service support programme, which meets the needs of all customers requiring warranty and after sales-service.

Services available in the **HAMEG** Service Programme include technical advice, information, repair and calibration, and the supply of spare parts and specialized equipment.

HAMEG has developed this service on a world-wide basis and therefore has support facilities in most parts of the

world. All service facilities can be contacted by telephone, most of them also by telex, and they are ready to provide the assistance and support required.

A list of **HAMEG** service offices is included on the back cover of this manual.

Operation Instructions

General

The HM 605 is just as easy to use as all other HAMEG oscilloscopes. The well designed and logical layout of front panel controls, indicators, and connectors ensure that the user will quickly learn how to operate the instrument. It must be stressed, however, that even experienced users and those new to the HM 605 are advised to read the instructions contained in this manual, before connecting the instrument to the power supply.

This manual contains important information which will enable all operators to obtain the maximum benefit and use from the HM 605 oscilloscope.

Connection to mains supply

Before connecting this oscilloscope to the mains supply check that it is set to the correct mains/line voltage. This oscilloscope operates from 110V, 125V, 220V, or 240V AC single phase, 50-60Hz, mains supply. On delivery, the instrument is set to operate from 220V \pm 10% (50-60Hz) line voltage, as indicated by the small "arrow" on the power plug-in-unit located at the rear of the instrument.

See Fig. 1 below

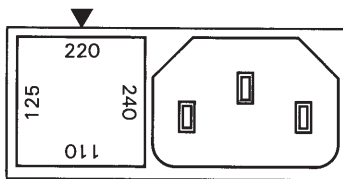

To change the operating voltage setting of the instrument to suit the local mains/line voltage, lever out the fuse holder in the square top plate, using a small screwdriver blade and turn it until the local mains/line voltage indication appears below the arrow. Replace the fuse holder in the selected position.

The power fuse must be rated according to the selected line voltage. If necessary replace it with the correct fuse as listed below:

<u>Line/mains Voltage</u>	<u>Fuse Rating</u>
110V \pm 10%	T0.63 Amp
125V \pm 10%	T0.63 Amp
220V \pm 10%	T0.315Amp
240V \pm 10%	T0.315Amp

Caution

The instrument must be disconnected and secured against unintentional operation. Investigate any suspicions that safe operation is not possible.

These could be

- if the instrument has visible damage,
- if the instrument has loose parts,
- if the instrument does not function,
- after a long storage under unfavourable circumstances (e.g. in moist environments),
- after hard transportation stress (e.g. in poor packaging).

Switching on and setting up (Refer to Fig. 20)

Preliminary checks

Before connecting power to the oscilloscope the following simple procedures should be performed:

- Check that instrument is set to correct mains/line voltage.
- Place instrument on a clear table or bench in a horizontal position, resting on tilt handle, to provide for maximum convection cooling.
- Check that all pushbutton switches are in OUT position, i.e. released.
- Rotate all variable controls with arrows, i.e. timebase fine control, Hold Off, Y I and Y II fine control, fully clockwise to CAL position.
- Set all other variable controls with marker lines to their mid-range position (marker line pointing vertically). See Fig. 20, (Front View).
- LEVEL control should be set to AT position, i.e. depressed.
- Slide switches TRIG and DELAY should be set to AC and NORM, respectively.
- Signal coupling slide switches for CH. I and CH. II should be set to GD position (input grounded).

Switch on and preliminary adjustments

- Switch on oscilloscope by depressing red POWER pushbutton. A yellow LED will illuminate to indicate that instrument is switched on.
- The trace, displaying one base line, should be visible after a short warm-up period of 10 seconds.
- Adjust Y POS I control to position base line.
- Adjust INTENS (intensity) and FOCUS for optimum brightness and sharpness of trace.

The oscilloscope is now ready for use. If only a spot appears (CAUTION – CRT phosphor can be damaged), reduce intensity and check that X-Y pushbutton is in released (out) position.

Caution

Intensity setting

To obtain maximum life from the cathode-ray tube, the

minimum intensity setting necessary for the measurement should be used. Particular care is required when a single spot is displayed. A very high intensity may cause damage to the fluorescent screen of the CRT.

If no trace appears, perform each of the following procedures until the cause is located:

- Increase INTENS (Intensity) control by slowly rotating it in a clockwise direction.
Return it to the centre position if trace does not appear.
- Check OVERSCAN indicators. If either is illuminated, adjust Y-POS I control until Overscan indicator is no longer illuminated.
- Recheck position of all controls as described for preliminary checks, especially LEVEL control.

With no input signal, the trace will only be displayed if the LEVEL control is set to the PEAK position (Automatic Triggering) i.e. depressed.

Trace alignment

When the oscilloscope is set up for operation, the horizontal trace position may not exactly align with the horizontal centre line of the graticule. This could be due to the Earth's magnetic field and cannot be completely avoided, even though the CRT is shielded with Mu-metal. Corrections can be made to the trace angle by adjustment of the TR (Trace Rotation) control located on the front panel, using a small screw driver.

Signal displays

General

All types of signals in the frequency range from DC to 60MHz can be displayed on the HM 605. The display of simple electrical processes such as sinusoidal AF and RF signals or ripple voltage poses no problems.

When square- or pulse-waveforms are displayed, the harmonic content of these signals must also be transmitted. In this case the bandwidth of the vertical amplifier must be much higher than the repetition rate of the signal. An accurate evaluation of such signals with the HM 605 is therefore only possible up to a maximum repetition rate of 6MHz.

Operating problems may sometimes occur when composite signals are to be displayed, especially if they do not contain any level components and a repetition frequency, which is suitable for triggering. This occurs, for example, with bursts. To obtain a stable triggered display in these cases, use NORM triggering, timebase variable control and/or the HOLD OFF control.

Video signals are relatively easy to trigger. When investigating these signals at frame rate, the TRIG. selector slide switch has to be set to the LF position (low-pass filter). In this mode, the more rapid line pulses are attenuated so that, with appropriate triggering level adjustment, triggering can easily be carried out on the leading or trailing edge of the frame synchronizing pulse.

For optional operation as a DC or AC voltage amplifier, each channel is provided with a DC-AC input coupling switch. The DC position should only be used with an attenuator probe or at very low frequencies, or if the measurement of the DC voltage content of the signal is absolutely necessary.

When investigating very low-frequency pulses, the flat tops may be sloping with AC coupling. In this case, DC operation is preferred, provided the signal voltage is not superimposed on a too high DC voltage level. Otherwise, a capacitor of adequate capacitance must be connected to the input of the vertical amplifier (with DC coupling). This capacitor must have a sufficiently high breakdown voltage rating. DC operation is also recommended for the display of logic and pulse signals, particularly if the pulse duty factor changes during operation. DC voltage can only be measured in the DC position of the input coupling switch.

Connection of test signal

The signal to be displayed should be connected to the vertical input of the oscilloscope by means of a shielded test cable, e.g. HZ32 or HZ34, or by probes (HZ50 - HZ55). The use of these shielded cables with high impedance circuits is only recommended for relatively low frequencies (up to approx. 50kHz). For higher frequencies, and when the signal source is of low impedance, a cable with characteristic impedance (usually 50 Ohm) or probes are recommended.

When investigating square or pulse waveforms, a resistor equal to the characteristic impedance of the cable must also be connected across the cable directly at the Y-input of the oscilloscope. When using a 50 Ohm cable, such as the HZ34, a 50 Ohm through-termination type HZ22 is available from HAMEG.

When observing square or pulse waveforms with fast risetimes, transient phenomena on the edges and top of the signal may become visible if the correct termination is not used. Note, that the 50 Ohm through-termination will only dissipate a maximum of 2 watts, which is reached with $10V_{\text{rms}}$ (or with $28V_{\text{pp}}$ sine signal).

If a x10 attenuator probe (e.g. HZ51) is used, no termination is necessary. In this case, the connecting cable is matched directly to the high impedance input of the oscilloscope.

When using attenuator probes, even high internal impedance sources are slightly loaded (by approx. 10 MΩ || 16 pF). If the voltage loss due to the attenuation of the probe can be compensated by a higher amplitude setting on the HM605, the probe should always be used. Remember that the series impedance of the probe provide a certain amount of protection for the oscilloscope input amplifier. It should be noted that all attenuator probes must be compensated in conjunction with the oscilloscope Y-input. (See: Probe Compensation).

If a x10 or x100 attenuator probe is used, always set the input coupling switch to DC. With AC coupling, the attenuation is frequency-dependent, and the pulses displayed can exhibit ramp-off. Furthermore, DC voltage contents are suppressed, but charge the input coupling capacitor of the oscilloscope. This has a maximum rating of 400V only (DC + peak AC). For suppressing disturbing DC voltages, a capacitor of adequate capacitance and voltage rating may be connected in series with the probe tip (e.g. for ripple measurements).

With the x100 probe the permissible AC input voltage is frequency dependent, limited to

under 20 kHz (TV line frequency) at
max. $1.200 V_p \triangleq 2.400 V_{pp} \triangleq 850 V_{rms}$

above 20 kHz (with f in MHz) at
max. $\frac{212 V_p}{\sqrt{f}} \triangleq \frac{424 V_{pp}}{\sqrt{f}} \triangleq \frac{150 V_{rms}}{\sqrt{f}}$

Low voltages

When investigating low voltages, the location of the ground connection on the test circuit can be critical. This should always be located as close as possible to the measuring point. If this is not done, serious signal distortion may result from spurious currents (HF or other) through the ground leads or chassis parts. This also applies to the ground leads on attenuator probes which, ideally, should be as short and thick as possible.

For measurements on BNC-sockets, the probe should preferably be placed in a BNC-adaptor (often supplied with probe accessories).

Hum

Hum or interference appearing on the measuring circuit (especially when a small deflection coefficient is used) could be caused by multiple grounding, as equalizing currents flow in the screening of the measuring cables. (A voltage drop across the earthed conductors of line-powered equipment, which is connected to the oscilloscope or test object. E.g. signal generators with anti-interference capacitors.)

Caution

When connecting unknown signals to the oscilloscope input, always set the DC-AC input coupling switch to AC and the Y-AMPL. switch to the 20V/cm position.

Amplitude limits

If the trace disappears after an input signal has been applied, the Y-AMPL. switch must be turned counterclockwise until the vertical signal height is about 3-7 cm.

With a signal amplitude greater than 400V_{pp}, an attenuator probe must first be connected to the oscilloscope's vertical input. If, after applying the signal, the trace is nearly blanked, the period of the signal is probably much greater than the set value on the TIMEBASE switch. It should be turned counterclockwise to a slower timebase speed.

High frequency signals

The HM605 accepts all signals up to a frequency of at least 60 MHz (-3 dB). For sinewave signals the upper frequency limit will be 60 MHz-85 MHz. In this higher frequency range, however, the vertical display height on the screen is limited to approx. 3-4 cm. Time resolution poses no problem. For example with a 100 MHz signal and the fastest adjustable time coefficient (5 ns/cm), one cycle will be displayed every 2 cm. The tolerance on indicated values is ±3% in both, X and Y directions. All values to be measured can therefore be determined relatively accurately, but it should be remembered that from approximately 25 MHz upwards the vertical measuring error will increase as a result of loss of gain. At 45 MHz this reduction is about 10%. Approximately 11% of the amplitude must be added to the measured value at this frequency.

As the bandwidth of the amplifiers differs between instruments (normally between 65 MHz and 70 MHz), the measured values in the upper limit range cannot be defined exactly. For frequencies above 60 MHz, the dynamic range of the display height decreases steadily.

The vertical axis

General

All signals to be measured are fed to the Y-plates of the CRT via the oscilloscope's vertical circuits. The main components of the vertical circuitry are the vertical amplifiers and the attenuators, which provide the relative factors for amplitude measurements.

All Y-axis controls are located in the Y-section of the front panel, as shown below, except the Y-OVERSCAN indi-

cators, which are to be found below the CRT screen. See Fig. 2, Y-Axis controls

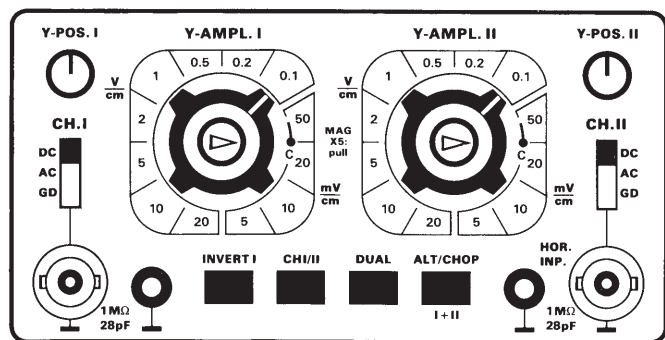

The HM605 has two input channels. Their signals can be displayed in various modes – single or dual trace – as selected by the four pushbutton switches. Each channel operates independently with separate input and attenuator.

Y-amplifiers and attenuators

The vertical input signal is fed to the Y-plates via the Y-input socket, a calibrated attenuator, and a chain of amplifier circuits.

Each input channel contains an input coupling selector, a variable attenuator, a pre-amplifier with diode-protected FET-input and an intermediate amplifier.

A specially selected diode gate switches the pre-amplifier outputs to the final vertical amplifier in accordance with its selected mode (MONO/DUAL, ALT/CHOP, SUM/DIFFERENCE). The final push-pull amplifier directly drives the vertical (Y) plates of the CRT.

The attenuator is a passive component (circuit), which couples the input signal to the pre-amplifier. The Y-amplifiers have a selectable magnification (x5) and the amplitude variable control, which is situated in the pre-amplifier. The attenuator setting is varied in calibrated steps by the channel amplitude switch, which has the purpose of reducing the signal level at the pre-amplifier when set at ranges higher than 5 mV/cm.

The display amplitude depends on the factor of the attenuator switch setting, which is given in V/cm or mV/cm, thereby relating the height of the display on the actual voltage value.

Modes of channel operation

The HAMEG HM605 can display signals via two oscilloscope channels in the following modes:

- MONO – either channel I or II is displayed
- DUAL – the two traces of channel I and II are displayed either alternately (ALT), or where both channels share the trace (CHOP). (This function occurs during one sweep period.)

- ADD ± The sum or difference of the signals on channel I and channel II can be displayed. (Depress INVERT I for display of difference.)
- X-Y Gives access to the X-plates via the Y II amplifier. The oscilloscope is operating without the internal timebase (e.g. for Lissajous figures).

Differential Measurement – both channels are used for measurements of a potential without reference to ground.

Selection of operating mode

The required operating mode can be selected by the following pushbuttons (see Front Panel diagram):

INVERT, CH I/II, DUAL, and ALT/CHOP – I+II, X-Y and TRIG I/II.

For Channel I MONO operation, the pushbuttons INVERT I, CH I/II, DUAL, and ALT/CHOP should be released, i.e. in the “out” position.

For Channel II MONO operation, the CH I/II and TRIG I/II pushbuttons should be depressed, i.e. in the “in” position. DUAL/ALT. mode is selected by depressing the DUAL and releasing the ALT/CHOP pushbuttons. In this mode both channels are displayed alternately. (Suitable for displaying high frequency signals.)

DUAL/CHOP. mode is selected by depressing the DUAL and ALT/CHOP. pushbuttons. In this mode both channels share the same trace. (Suitable for displaying very low frequency signals.)

ADD (plus) mode is selected by depressing ALT/CHOP (I+II) only, while TRIG. I/II, INVERT I, CH I/II, and DUAL are in the released position. In this mode the sum of the signals of channel I and channel II is displayed.

SUBTRACT (minus) mode is selected by depressing the INVERT I pushbutton. All other switches are to remain as in ADD (plus) mode. In this mode the difference between the two signals is displayed.

In the ADD/SUBTRACT modes the vertical position of both channels are controlled by the Y-POS. I and Y-POS. II controls.

X-Y OPERATION is obtained by depressing the X-Y pushbutton. The X-signal is to be connected to the channel II input (HOR. INP.). Do not allow a bright spot to remain on the screen otherwise the CRT phosphor may be damaged.

DIFFERENTIAL mode is applied when a signal voltage between two “high points” is measured independent of ground, i.e. without using ground as a reference point. Differential measurements can be performed by using both channels of the oscilloscope. See page M 9 for measurement procedure.

Overscan indication

The HAMEG HM605 features a vertical (Y) overscan indication for ease of operation. Two LED indicators marked OVERSCAN, located on the front panel directly under the

CRT, will illuminate if any part of the trace has left the vertical limits of the internal graticule. This can be up, down, or both, as indicated by the OVERSCAN LEDs. The overscan facility operates with the baseline or with signals of more than 100 ns length.

Overscanning can occur if

- the Y-position controls are not adjusted correctly in MONO and DUAL operating modes.
- the attenuator controls are set incorrectly.
- AC signals with excessive DC potential are measured (when the input coupling switch is set to DC).

In this case switch to AC input coupling or add a suitable capacitor in series with the Y-input connector.

Oscilloscope probe adjustment

The oscilloscope attenuator probe should be adjusted periodically to ensure a correct divider ratio and an undistorted display of waveforms. The probe must be compensated to match the input impedance of the respective channel.

For this purpose the instrument contains a special built-in squarewave generator. The generator output ($0.2V_{pp}$ and $2V_{pp} \pm 1\%$ at approx. 1 kHz or 1 MHz) is at the CAL. 0.2V and 2V test sockets located beneath the CRT on the front panel, also the switch for calibrator frequency selection.

The method of probe compensation is as follows:

- Set CALIBRATOR switch to 1 kHz.
- Set TIMEBASE switch to 0.2 ms/cm.
- Set channel input switch (I or II) to DC.
- Set Y-AMPLITUDE switch to 5 mV/cm.
- Connect probe to the CAL. 0.2V test socket on front panel.
- The CRT can display one of the following waveforms:

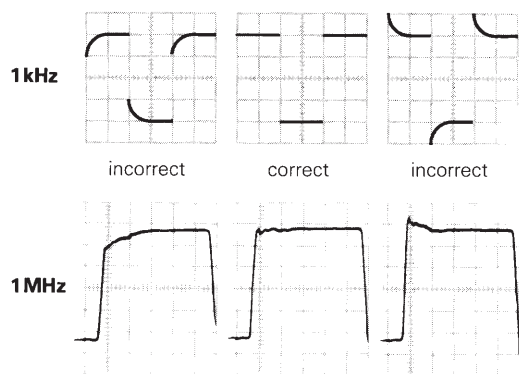

- If either of the incorrect displays appear, adjust the probe trimmer control until the correct waveform is obtained, using the special trimming tool supplied with the probe. The probe trimmer is located in the body of the probe or its connecting box.

For adjustment of the new HAMEG HF-Modular Probe HZ52 proceed as follows:

- Follow the above-mentioned procedure, then:
- Set CALIBRATOR switch to 1 MHz.
- Set TIMEBASE switch to 0.2 μ s/cm.

- Set channel input switch (I or II) to DC.
- Set Y-AMPLITUDE switch to 5 mV/cm.
- Connect probe to the CAL. 0.2V test socket on the front panel.
- Adjust the 3 trimming pots in the connecting box of the probe for best results.
- The CAL. 2V test socket should be used for x100 probe adjustment.

Amplitude measurements

General

One of the main uses of the oscilloscope is for signal amplitude measurements of DC, sinewave and complex waveforms. The HAMEG HM605 is designed for accurate measurement of signals from $1mV_{pp}$ to $2400V_{pp}$ (with the use of the HZ53 High Voltage Probe). Signals smaller than $1mV_{pp}$ can also be displayed (pull MAG x5). The maximum signal that can be applied to the input of the vertical amplifiers without external attenuator probe is $400V_{pp}$.

All amplitude measurements are made using the Y I and Y II channels, where the relative values are displayed on the CRT screen. The value of the required amplitude can be measured in cm (physical height). This reading is then converted to voltage by multiplying the cm value by the relative factor indicated by the AMPLITUDE switch setting, the deflection coefficient, either in V/cm (volts per centimeter) or in mV/cm.

During calibrated measurements the amplitude variable control has to be set at C (cal.) position. The attenuation factor of the probe has to be allowed for.

Method of measurement

When using the oscilloscope for voltage measurements the following method can be used.

PRELIMINARY CHECKS

Before the signal is connected, check the settings of the oscilloscope controls as follows

- AMPLITUDE switches on both channels set to 20V/cm, and AMPLITUDE VARIABLE control in C (cal.) position and depressed.
- All pushbutton switches are in the released (out) position.
- Set channel INPUT COUPLING switch to AC, unless a known DC voltage is to be measured.
- Set TRIGGER LEVEL switch to AT (depressed).
- Adjust the trace position, INTENS and FOCUS. Check that DELAY is switched to NORM.

APPLICATION OF SIGNAL

- Select channel mode as required.
- Apply signal and adjust AMPLITUDE switch setting for a 3-4 cm signal height.
- Adjust TIMEBASE and triggering controls, if required, for an optimal display. (See Fig. 3).

- Measurements of display amplitude are made with the graticule, which is scaled in cm. The Y position control can be used to adjust trace to a suitable reference line.
- Record display height in cm and AMPLITUDE switch setting in V/cm and calculate the signal voltage.

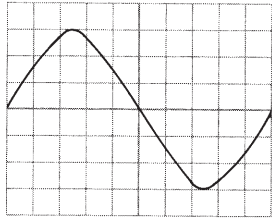

Fig. 3, Sine Wave

Calculation of the voltage value is performed as follows:
(Refer to Fig. 4)

$$\begin{aligned} \text{Voltage (V)} &= \text{Height in cm (H)} \times \\ &\quad \text{Amplitude switch setting} \\ &\quad \text{in mV/cm or V/cm (A)} \\ V &= H \times A \end{aligned}$$

Values for V, H, and A must be within the limits of the oscilloscope, i.e. for

- V – between 1 mV_{pp} and 160V_{pp}
- H – between 0.5 and 8 cm (optimum 3.8 to 8 cm)
- A – between 1 mV/cm and 20V/cm.

Example 1 (See Fig. 4)

$$\begin{aligned} H &= 8 \text{ cm (peak to peak)} \\ A &= \text{Amplitude switch setting} = 2 \text{ V/cm} \\ \text{Then } V &= \text{Voltage value peak-to-peak} \\ V &= H \times A \\ &= 8 \times 2 \text{ (V)} = \underline{16 \text{ Volts}_{pp}} \end{aligned}$$

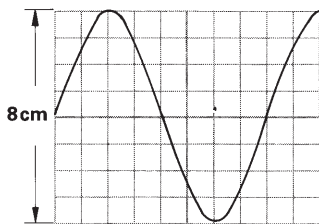

Fig. 4

Example 2 (See Fig. 5)

$$\begin{aligned} H &= 4 \text{ cm peak value (V}_p\text{)} \\ A &= 0.2 \text{ V/cm} \\ V &= H \times A \\ &= 0.2 \times 4 \text{ (V)} \\ &= \underline{0.8 \text{ V}_p} \end{aligned}$$

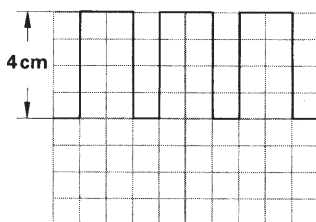

Fig. 5

Example 3 (See Fig. 4) using a x10 Attenuator probe

$$\begin{aligned} H &= 8 \text{ cm peak-to-peak} \\ A &= 20 \text{ mV/cm} \\ V &= H \times A \times (\text{Probe factor}) \\ &= 8 \times 20 \text{ (mV)} \times 10 \\ &= 160 \text{ mV} \times 10 \\ &= 1600 \text{ mV}_{pp} = \underline{1.6 \text{ Volts}_{pp}} \end{aligned}$$

AC measurements

In general, AC voltage values normally refer to the rms value (root-mean-square value). However, for signal voltages in oscilloscope measurements, the peak-to-peak voltage (V_{pp}) value is used. This is the potential difference between the most positive and the most negative point of a waveform.

If the peak-to-peak value V_{pp} of a sinewave, displayed on the oscilloscope screen, is to be converted into an rms-value, the resulting peak-to-peak value must be divided by $2 \times \sqrt{2} = 2.83$

$$\text{i.e. } V_{rms} = \frac{V_{pp}}{2 \times \sqrt{2}} = \frac{V_{pp}}{2.83}$$

Conversely,

$$V_{pp} = V_{rms} \times 2.83$$

The relationship between the different voltage values can be seen in Fig. 6.

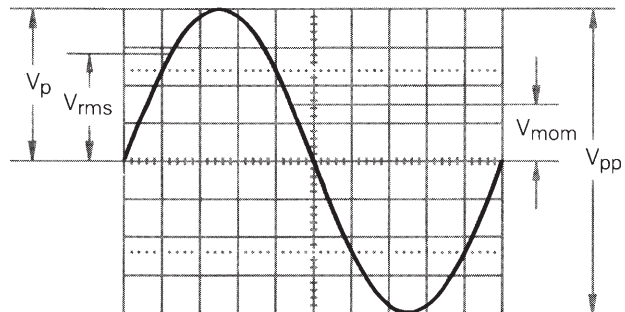

Fig. 6, Voltage values of a sinewave.

V_{rms} = root-mean-square value; V_p = simple peak or crest value;
 V_{pp} = peak-to-peak value; V_{mom} = momentary value.

DC measurements

For DC measurements a single trace line is required. The timebase and trigger controls have no effect on the actual measurement.

DC measurements can be made in the following way:

- Set the respective channel input selector switch to DC. Adjust the Y-POS control to position the trace on a reference line of the graticule.
- When a DC voltage is applied to the selected Y input, the trace will move up for positive or down for negative voltages, when using ground as reference.
- The trace displacement can be measured in cm. The DC value can be calculated as follows:

DC voltage = Height (H) in cm x Amplitude (A) in mV or V/cm

Example 1 H = 3 cm (down)
 A = 2 V/cm
V = -6V

Example 2 H = 3 cm (up)
 A = 0.2 V/cm
 Probe = x10
V = 6V

Differential measurement

Note: For this type of measurement **two** identical probes are required.

Caution: Remove ground clips from both probes.

Measurements can be made in the following way

- Connect probes to channel I and II inputs.
- Depress INVERT I and I+II mode pushbutton switches.
- Ensure CH I+II and DUAL pushbuttons are released.
- Set amplitude switches YI and YII to 20V/cm and input selector switches to AC.
- Connect both probes across the circuit component, where the signal is to be measured. (See Fig. 7)
- Adjust oscilloscope controls for optimal display, ensuring that both amplitude switches are set to equal ranges.
- For DC differential measurements both channel input selector switches should be set to DC.
- If trace moves up CH II input is positive,
- If trace moves down CH I input is negative.

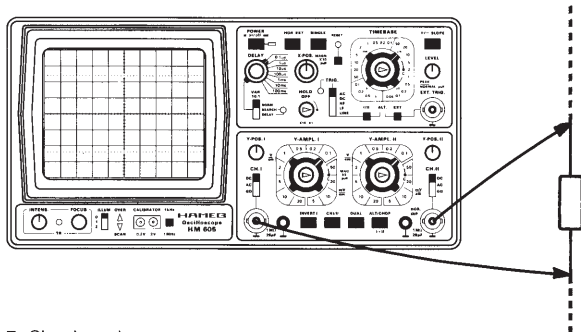

Fig. 7, Circuit under test

High voltage measurement

For DC measurements up to 160V_{pp} the input selector switch must be set to DC.

AC measurements can be made with the switch set to AC, but if the applied signal is superimposed on a DC (direct voltage) level, the total value (DC + peak value of the alternating voltage) of the signal must not exceed ±400V.

This same order of magnitude applies to normal x10 attenuator probes. The attenuation allows signal voltages up to approx. 600V to be evaluated.

Voltages of up to approx. 1200V can be measured using the HZ53 High Voltage Probe, which has an attenuation of x100.

It should be noted that the V_{rms} value is derated at high frequencies if a normal x10 probe is used to measure high voltages. (See page M 5, HF signals).

There is also a risk that the attenuator series resistor of the probe will break down, causing damage to the input of the oscilloscope.

If the residual ripple of a high DC voltage is to be displayed, a normal x10 probe can be used, but the probe must be in series with an appropriate HV rated capacitor (22 to 68nF).

The horizontal axis

Except for X-Y operation, the horizontal or "X"-axis is used on the oscilloscope for all time and frequency related measurements or observations.

The primary function of the X-axis is to deflect the CRT beam to produce the horizontal display.

This is achieved basically by the timebase generator and the X plates of the CRT.

All X-axis controls and related components are contained in the X-axis section of the front panel.

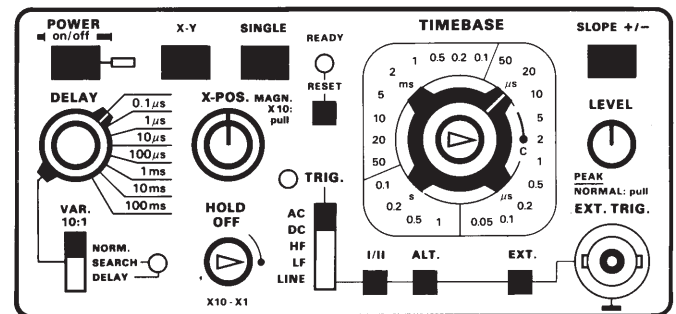

Fig. 8, X-Axis Controls

The timebase

The timebase determines the time required by the CRT's electron beam to move once across the screen in the horizontal direction (sweep time).

The sweep time is the basis for all signal frequency and time measurements.

The sweep time is determined by the timebase generator and is selected with the timebase switch. The settings on the timebase switch give the time coefficient or sweep time per cm, either in seconds (s), milliseconds (ms), or microseconds (µs). Time coefficients range from 0.05µs/cm to 1s/cm. For example, at the sweep rate of 0.1 s/cm, it will take one second to travel the full length of the screen (10cm).

Timebase controls

The **Timebase rotary switch** enables the time coefficients to be selected within a range from 1 s/cm to 0.05 μ s/cm in 23 calibrated steps.

The variation of this switch also enables the number of signal cycles displayed on the CRT to be increased (turning the switch counter-clockwise) or decreased (turning the switch clockwise).

The **Timebase variable control** varies the time coefficient by decreasing it from the value shown on the timebase switch. When the control is turned fully counter-clockwise, the sweep time is increased by a factor of approx. 2.5:1. For exact measurements, the timebase variable control must be set to the C (calibrated) position.

The **X MAGN x10** pull-switch gives the facility of expanding the trace by a factor of 10 ($\pm 5\%$).

The maximum timebase resolution (5 ns/cm) can be obtained by using the X MAGN x10 facility and turning the timebase variable control fully clockwise.

If any part of the signal requires time expansion, e.g. to examine a particular spike on the waveform, first of all using the X-POS, position the spike on the vertical centre line and then pull X MAGN x10. The desired part of the expanded signal will now be displayed approximately in the centre of the screen.

Timebase triggering

Triggering modes

The **HAMEG HM 605** has a full range of timebase triggering modes, which produce the stable display needed for measurement and observations.

All triggering modes enable the timebase sweep signal, which produces the X trace, to be started at the same time as an applied test signal. This is done by the trigger signal, which enables the timebase generator and test signal to be synchronized to produce a perfectly stable signal display. The trigger signal has to be derived either from the test signal or from an external source. The built-in delay line permits viewing of the trigger edge of the displayed signal.

The various trigger modes available on the **HAMEG HM 605** are:

- **PEAK** (Peak Value Trigger)

The timebase will be triggered automatically from the peak value (maximum voltage) of the test signal. In this mode, the trace base line will be displayed without any input signal being present or with the input selector switched to GD. Most non-complex signals above 30 Hz can be displayed in a stable condition in PEAK mode, but

signals under 5 mm in amplitude may not have sufficient amplitude to trigger the timebase.

- **NORMAL**

In this mode, triggering is achieved by adjustment of the LEVEL control. Further adjustment of this control selects the voltage point on the trigger signal, where triggering occurs. The trigger signal can be derived from any point on the positive or negative edge of the test signal. This is adjusted by the level control and slope +/– switch. With normal triggering, level range is dependent on the amplitude (height) of the display. If it is less than 1 cm, the level control can be very sensitive.

- **EXT** (External Trigger Source)

This mode enables an external trigger signal to be connected to the oscilloscope at the EXT TRIG socket. When connected to the EXT TRIG input, the signal should have an amplitude from 50 mV_{pp} to 0.5 V_{pp}.

External trigger signals, which are not within this voltage range or not known, can be applied to the channel II input. The channel II amplitude control can then be used to adjust the trigger signal amplitude in the range from 5 mV_{pp} to 400 V_{pp}.

The external trigger signal can be observed on channel II simply by depressing the CH I/II mode switch. It can then be set to a suitable amplitude (3 to 6 cm). The CH I/II switch can then be released, but the I/II Trigger pushbutton must remain depressed.

- **SINGLE**

A single shot triggering facility enables the timebase to sweep the CRT once only. This is used when a single process or event is required to be displayed or photographed, e.g. the voltage decay in a resonant circuit. The single trigger signal pulse is derived from the input signal with either PEAK or NORMAL trigger mode.

To switch the oscilloscope to single sweep operation, the SINGLE pushbutton switch is depressed, whereby the RESET pushbutton should be pressed to illuminate the READY LED. This shows that the oscilloscope is ready to accept an input signal.

When an input signal is applied, the signal appears momentarily and the READY LED will go out. To repeat the sweep, the RESET pushbutton has to be reset, and another signal has to be applied.

Triggering in automatic mode will cause the single displayed signal to start approximately on the base line, but in this mode the trigger circuit is very sensitive and small interference signals can prematurely trigger the signal sweep. For triggering with low amplitudes (high sensitivity) or very low frequencies, the normal mode triggering should be used.

The setting of the level control amplitude and timebase should be determined before signal sweep is used.

Line

This mode enables the timebase to be triggered by a signal derived from the line/mains supply, either 50Hz or 60Hz depending on the line frequency. In this mode the trigger signal is independent of the frequency and amplitude of the Y signal. It can be used when investigating signals which are related to the line supply, i.e. line signals, harmonics or sub-harmonics.

This mode is useful for measurement of small hum signals or line supplied DC power supplies, or line frequency control and clock circuits.

NOTE: If a negative slope triggering level is observed with the + slope selected, this is due to the phase reversal of the line supply. To correct this the line/mains supply connections must be reversed.

Explanation of trigger controls

The trigger controls are located in the timebase section of the front panel. They enable a wide and flexible use of the HM605's many timebase and trigger facilities. A short description of their use is as follows:

LEVEL

The level control is operated in all triggering modes and is used to select a trigger signal from a chosen level of amplitude from a part of the input signal (a point on the + or – edge), when a signal shape is constant and continuous, (e.g. sine-wave) or a particular signal (pulse level), if the repeating signals are not at a constant amplitude or frequency.

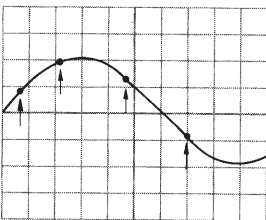

Fig. 9
Trigger signal can be selected at any level on the signal curve.

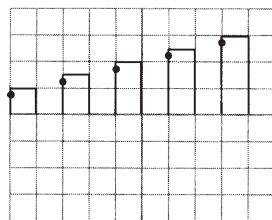

Fig. 10
The level control can be adjusted to select one particular pulse to be used as a trigger signal.

PEAK/NORM switch

Operated by the level control knob, push in for automatic trigger, pull out for normal trigger.

Trigger indicator

The Trigger Indicator LED will illuminate when the timebase has been triggered. This will operate in all modes of triggering. The indicator is particularly useful when triggering very low frequency signals and will illuminate to show that a trigger signal has been located during sensitive adjustment. In

some cases, the trigger indicator will flash, e.g. low frequency signals.

Trigger coupling selector and other controls

The trigger coupling selector switch is marked AC, DC, HF, LF, LINE and operates with external and internal trigger signals.

Various modes can be selected, so that the trigger signal can be matched to the input signal under test, depending on the type and frequency of the signal.

- The **AC** position can be selected when investigating most types of uncomplicated waveforms.
- **DC** coupling is used when displaying very low frequency signals and when it is required to trigger the signal at a specially selected voltage point (level), or when the signal constantly changes during investigation. When using DC coupling, NORMAL mode triggering should be selected.
- The **LF** (Low Frequency) position is specially suited to trigger video signals at frame frequency. It can also be applied to all signals under 800Hz. This facility uses a low pass filter to suppress high frequency interference signals, which may be contained in the trigger signal.
- The **HF** (High Frequency) position switches in a high pass filter, which eliminates DC variation and LF interference, which could affect the trigger signal. It is useful for high signal frequencies up to 80MHz.
- **LINE**. This position selects the Line Triggering Mode. (See Trigger Modes).
- **SINGLE/RESET**
The SINGLE pushbutton enables the oscilloscope's timebase generator to be set to single shot mode. The READY LED illuminates when single shot mode is ready or in operation. To arm for single shot operation, the RESET pushbutton should be pressed to illuminate the LED. The READY LED is dark when the signal sweep is run down.
- **HOLD OFF**
This control adjusts the time between sweeps, i.e. between two complete scans. This control may be useful when triggering in aperiodic signals, complex waveforms or bursts, to obtain a stable display.
- **SLOPE +/-**
A triggering signal can be selected at any point on the positive (+) or negative (–) edge of the test signal. The slope +/- switch determines which edge of the signal will be used to obtain the triggering signal. Slope selection is important when only parts of the signals are displayed.

Triggering instructions

To trigger the timebase, the following instructions should be performed:

1) **PEAK (Automatic Peak Value Trigger) mode**

- a) With no input signal connected, set up oscilloscope for normal operation, i.e. all pushbuttons released.
- b) Select required trigger coupling (AC, DC, HF, LF)
- c) Push LEVEL control knob in and adjust to position PEAK.
- d) Connect input signal. A display should appear and trigger indicator should illuminate.
- e) Adjust timebase and amplitude controls to obtain required signal display.

2) **NORMAL trigger mode**

- a) Repeat steps a) to e) as under PEAK mode.
- b) Adjust Y amplitude for a display height between 1 and 8 cm.
- c) Adjust LEVEL control to centre position and then pull LEVEL control OUT.
- d) Select required triggering point by further adjustment of LEVEL control.

3) **LINE mode**

- a) Set TRIG. coupling switch to LINE.
- b) Apply a line frequency related signal.

4) **EXTERNAL Triggering mode for signal**

50mV_{pp} to 0.5V_{pp}

- a) Repeat steps a) to e) as shown for Automatic Triggering, but note that the trigger indicator will not illuminate.
- b) Connect the external trigger signal to the EXT TRIG input socket.
- c) Depress EXT. pushbutton switch.
- d) The trigger indicator should illuminate and a trace should be displayed.
- e) Pull level control knob for normal trigger mode, if required, and adjust for a stable display.

5) **External Triggering mode via Channel II**

- a) Repeat steps a) to e) as for Automatic Triggering, but note that the trigger indicator will not illuminate.
- b) Connect the external trigger signal to the Channel II input connector and depress the CH I/II pushbutton. Depress TRIG I/II pushbutton.
- c) Observe the external trigger signal display and adjust amplitude switch Y II for a display between 2 and 6 cm height.
- d) Release CH I/II pushbutton. Channel I now is in operation and the trigger signal is fed via Channel II.

6) **SINGLE SWEEP Triggering mode**

- a) Repeat instructions a) to e) as for Automatic Triggering mode.

- b) Determine amplitude and frequency of test signal and adjust timebase, trigger mode and amplitude controls accordingly.

- c) Depress SINGLE pushbutton. Briefly press RESET pushbutton, which should now illuminate the LED.

- d) Connect test signal to channel input. A trace should now appear and the READY LED should go out.

Push RESET pushbutton again, so that oscilloscope is ready for next signal.

Note: Ensure SINGLE pushbutton is released when measurements finished. This avoids confusion when normal timebase operation is used.

Triggering complex signals

Use of Hold Off control

If it is found that a triggering point cannot be located on complex signals after repeated adjustment of the LEVEL control in normal mode, it may be possible to obtain a trigger point by adjusting the fine frequency control in either PEAK or NORMAL mode.

For aperiodic signals such as complex digital words, the HOLD OFF control may be used. This control varies the hold off time between two sweeps, during which time no triggering is possible. The HOLD OFF control can increase the time between sweeps by a factor of 10. Pulses or signals appearing during this "off" period cannot trigger the timebase. With pulse trains of the same amplitude, the start of the sweep can be shifted to the required pulse, e.g. the second with double pulses or with "bursts" of signals.

The HOLD OFF control should always be returned to the cal. position x1 otherwise the display brightness will be reduced.

Sweep Delay

General

During normal timebase operation, the trigger signal starts the sweep, i.e. the timebase sweep signal will begin at exactly the same instant as the trigger signal is applied.

The HAMEG HM605's sweep delay facility enables the sweep to be started at selected delayed times after the trigger signal has been applied. The delay time ranges from 0.1 μ s to 100 ms, with its fine control to max. 1 s.

The sweep delay facility therefore makes it possible to start the sweep at practically any point of the waveform. The period, which follows the start of this sweep, can then be

expanded by an increase of timebase speed. From a $5\mu\text{s}/\text{cm}$ timebase range downward to slower sweep speeds, an expansion of at least 1000 times is possible. With timebase speeds faster than $5\mu\text{s}/\text{cm}$, the maximum expansion decreases proportionally.

By an extreme increasing of the expansion, the delay brightness decreases and trace focus may change. In these cases an HZ47 viewing hood should be used.

When the expansion is very large, the signal displayed may have a tendency to jitter. This may be caused by slight changes in signal frequency.

Explanation of controls

The sweep delay facility has three controls which are located in the timebase section of the front panel. A short description of their use is as follows:

- DELAY
 - time selector. This switch has seven positions ranging from $0.1\mu\text{s}$ to 100 ms. Used for coarse selection of delay times.
- DELAY VAR
 - control. This fine control is used for fine time delay adjustments depending on the setting of the coarse position switch. The control consists of a twenty-turn precision potentiometer with overwind protection.
- NORM – SEARCH – DELAY
 - This switch selects both delay modes.
- NORM
 - In this position the delay circuit is switched off and the complete waveform under investigation will be displayed.
- SEARCH
 - In this position, the CRT display will show the amount of delay, i.e. blank the trace on the left of the CRT screen. Using the DELAY switch and the DELAY VAR, the delay can be adjusted to select a particular point of the displayed signal or predetermined delay time. The delay time is then the distance from the extreme left of the graticule to the beginning of the trace and is dependent on the timebase setting.
 - The DELAY Indicator LED will flash in SEARCH mode.
- DELAY
 - In this position the display is delayed by the time determined during SEARCH mode. Adjustment of the delay time (fine or coarse) will have the effect of moving the signal, but the part of the signal seen on the CRT screen will keep the same time coefficients as shown on the timebase switch.
 - Another effect is that the displayed signal will move with

the adjustment of the delay fine control. This can be regarded as the graticule moving along the trace. The DELAY Indicator LED will illuminate continuously in DELAY mode.

Operation of DELAY facility

1. With no signal applied or channel input selector switch set to GD, adjust the X POS control so that the trace is centered in the graticule. Ensure that DELAY mode switch is set to NORM and adjust oscilloscope to display one to five basic periods of the signal under investigation.
2. Set DELAY mode controls (fine and coarse) fully counterclockwise.
3. Check that X MAGN x10 switch is depressed, HOLD OFF control set to x1, and TIMEBASE VAR control set to C (calibrated).
4. Check that trigger LEVEL control is adjusted to ensure stable triggering. The TRIG. LED should be illuminated.

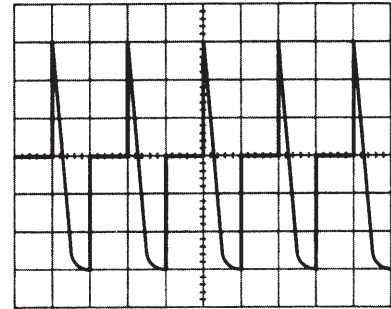

Fig. 11: Example of Trace
Mode: Norm, Timebase: $0.5\text{ms}/\text{cm}$

Search mode

1. Set DELAY switch to SEARCH position. The DELAY LED indicator will flash.
2. Increase DELAY coarse and VARIABLE control for required delay time. The start of the trace will move to right of graticule. The amount of shift indicates the delay time. If trace disappears, then the delay time setting is too high

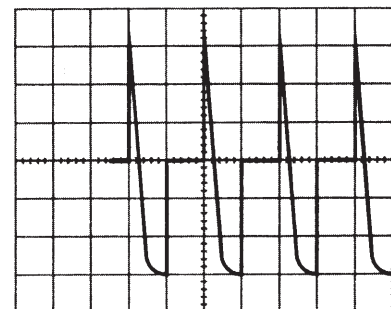

Fig. 12: Example of Trace
Frequency: 1 kHz, Mode: Search,
Delay range: 1 ms, Timebase: $0.5\text{ms}/\text{cm}$
Delay LED: Flashing, Delay Time: $2.5\text{cm} \times 0.5\text{ms}/\text{cm} = 1.25\text{ms}$

- The X POS. control should not be adjusted. Precise adjustment of the delay time is made with the DELAY VAR control. This can then be calculated from the timebase switch setting.

Note: When investigating a waveform as shown in Fig. 11 above, the display could not be obtained with a time delay setting of 10ms and display would be completely blanked. A delay of 0.1 μ s, however, would not be sufficient to delay the sweep to a visible amount. The delay switches should be slowly rotated clockwise until the trace starts, just prior to the time interval required to be investigated.

Delay Mode

- Set mode switch to DELAY position. The DELAY LED indicator should constantly illuminate.
- The trace will now start in the same position as for normal display. The signal position can be adjusted by the DELAY VAR control.

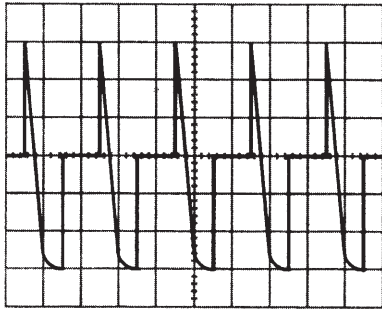

Fig. 13: Example of Trace
Mode: DELAY, Delay range: 1 ms
Timebase: 0.5ms/cm, LED: illuminated

Expansion of signal

- In the DELAY mode, the required part of the signal can be displayed by adjusting the DELAY VAR control.
- Increase the timebase sweep speed to expand the displayed signal as required. The TIMEBASE VAR control and the X MAGN x10 facility may have to be used.
- If the signal leaves the CRT screen, the DELAY VAR control requires readjustment. This control can be adjusted to enable any point of the signal to be displayed.

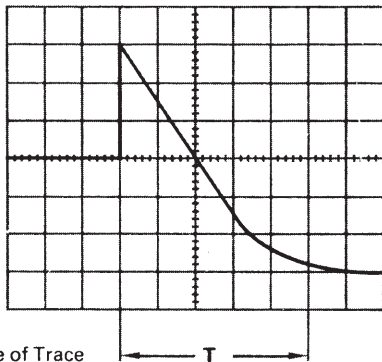

Fig. 14: Example of Trace
Mode: Delay, Delay range 1 ms,
Timebase: 50 μ s/cm, LED illuminated,
Expansion: $0.5 \cdot 10^{-3} : 50 \cdot 10^{-6} = 10$,
 $T = 5 \text{ cm} \cdot 50 \mu\text{s/cm} = 250 \mu\text{s}$

In the example shown in Fig. 14 above, it can be seen that an expansion of x10 was obtained by increasing the timebase sweep speed from 0.5ms/cm to 50 μ s/cm. The precise measurement for the delayed portion of the waveform is possible. This was found to be 250 μ s by multiplication of the horizontal length in cm (of an optional signal section) by the timebase time coefficient. The Timebase VAR control must always be set at C (calibrated) when accurate measurements are to be made.

Time and frequency measurements

General

Generally, all signals to be displayed are periodically repeating processes, which can also be designated as time periods. The number of periods per second is the frequency or repetition rate of the signal. One or more signal periods or even part of a period can be displayed on the oscilloscope's CRT.

By using the X-coordinate (graticule) and the timebase, the oscilloscope can be used to measure the time period or frequency of any signal, as well as measuring rise time of individual pulses.

One or more signal periods and parts of a signal period can be displayed. The "quantity" of signals depends on the setting of the timebase switch.

The timebase represents the time it makes for the trace to travel across the CRT in the horizontal (X) direction. It is adjustable from 1s/cm to 0.05 μ s/cm by rotating the TIMEBASE switch. Time coefficients on the TIMEBASE switch are indicated in s/cm (seconds/cm), ms/cm (milliseconds/cm) and μ s/cm (microseconds/cm). See also diagram of Front Panel.

Measurements

TIME and FREQUENCY measurements can easily be obtained by "reading" the X-axis distance (cm) from the CRT graticule. See Fig. 15 below:

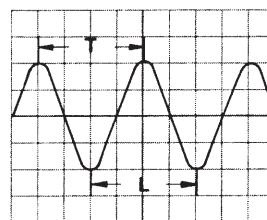

Fig. 15, where T = Time (duration) of ONE signal period
L = Length of one period in cm (read from CRT graticule)

From the TIMEBASE coefficient Z (s/cm) as indicated on the TIMEBASE switch, the true time duration of one period can be calculated using the simple formula

$$T = L \times Z$$

The Frequency (F) of the signal can be determined from the time (T) of one period by:

$$F = \frac{1}{T} \quad \text{thus, } T = \frac{1}{F}$$

Example 1 (See Fig. 16)

L = 4 cm
 Z = 5 ms/cm (Timebase switch indication)
 Required time $T = 4 \times 5 \times 10^{-3}$
 Thus, $T = 20 \text{ ms}$

$$\text{Required frequency } F = \frac{1}{20 \times 10^{-3}} = \frac{1000}{20} = 50 \text{ Hz}$$

$$\text{or } F = \frac{1}{20 \text{ ms}} = \frac{1000}{20} = 50 \text{ Hz}$$

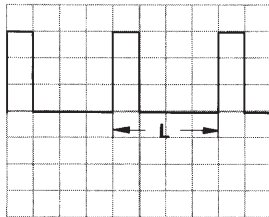

Fig. 16

Example 2 (See Fig. 17)

L = 1 cm
 Z = $1 \mu\text{s/cm} = (1 \times 10^{-6}) \text{ sec/cm}$
 Required time $T = 1 \times (1 \times 10^{-6})$
 thus $T = 1 \times 10^{-6} = 1 \mu\text{s}$

$$\text{Required frequency } F = \frac{1}{1 \times 10^{-6}} \quad (\text{Hz})$$

$$\text{thus } F = \frac{10^6}{1} = 1 \text{ MHz}$$

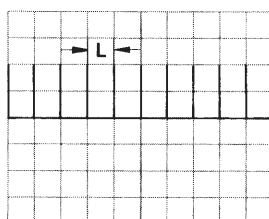

Fig. 17

Use of controls for time and frequency measurements

When using the oscilloscope to measure time or frequency, check that the following controls are correctly set:

TIMEBASE switch –

adjusted to give a readable display of 1 or 2 periods or “part” of the signal to be measured.

TIMEBASE VAR control –

(located in centre of timebase switch)

should be set to C (calibrated) position, with arrow pointing to right.

X-MAGN x10 –

This switch should be depressed.

When this switch is pulled out, the timebase scale is expanded by a factor of 10 and must be allowed for in the calculation by dividing by 10.

TRIGGER LEVEL –

Control to be adjusted to give a stable display.

Y-AMPLITUDE –

Set controls to give at least 5 cm signal height.

X POS and Y POS –

Adjust these controls so that the signal is symmetrically positioned to the horizontal and vertical centre lines of the graticule.

DELAY –

This facility should be used when very small time intervals at selected parts of the signal are to be measured – see section Sweep Delay.

Note: Time intervals smaller than 1% of the total signal period can be measured using the sweep delay mode.

CRT INTENSITY –

At fast sweep rates, the CRT intensity may be lower and should be increased as required. Using the oscilloscope Viewing Hood HZ47 will improve contrast.

Measurement of rise time

One of the critical features of a square wave or pulse is the time taken to change the level or voltage.

This time is referred to as the rise time (or fall time) t_{tot} , and is normally measured between 10% and 90% of the pulse height. See Fig. 18 below. The 10% to 90% limit is used to ensure that transients, ramp-offs and bandwidth limitations do not influence the measuring accuracy.

Use of graticule during rise time measurements

The HM605 CRT’s internal graticule is especially calibrated and divided for rise time measurements. (See Fig. 18 below).

For peak-to-peak signal amplitude of 6 cm height which are symmetrically adjusted to horizontal centre line the internal

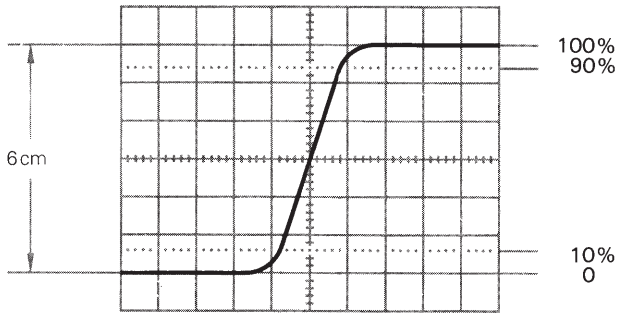

Fig. 18

graticule of the CRT has two horizontal dotted lines ± 2.4 cm from the centre line, providing predetermined 10% and 90% signal points.

Suggested measurement procedure

1. Adjust TIMEBASE controls until pulse is displayed as shown in Fig. 18 above. The X POS, X MAGN x10, and the sweep delay facility may have to be used.
2. Adjust Y AMPL selector switch, fine control, and Y POS to align average peak value with the ± 3 cm horizontal lines on internal graticule.
3. Measure distance (time t_{tot}) between the two points at which trace crosses the dotted lines 2.4 cm above and below the centre line (See Fig. 18).
4. The distance represents the rise time. Rise time can be calculated as follows:

$$\text{Rise time } t_{tot} = \frac{D \times T/\text{cm}}{\text{MAG}}$$

Where D = Distance in cm
 T = Timebase setting
 MAG = X-Magnification switch
 = 1 (pushed)
 = 10 (when pulled)

Example 1 (See Fig. 19)

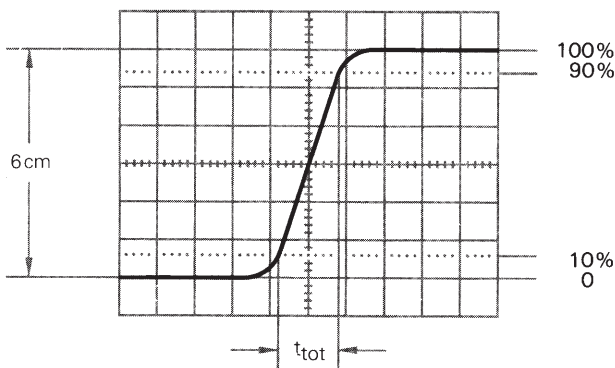

Fig. 19, Rise time Measurement
 D = 1.6 cm, T = 1 μ s/cm
 MAG = 1 (not used)
 $t_{tot} = 1.6 \times 1 \times 10^{-6}$ sec.
 = 1.6 μ s

Example 2

Here, D = 1.6 cm
 T = 0.2 μ s/cm
 MAG = 10

$$t_{tot} = \frac{1.6 \times 0.2 \times 10^{-6}}{10}$$

$$= \frac{0.32 \mu\text{s}}{10} = 32 \text{ ns}$$

When very fast rise times are being measured, the rise time of the oscilloscope amplifiers has to be deducted from the measured time value. The rise time of the signal can be calculated from the following formula:

$$t_r = \sqrt{t_{tot}^2 - t_{osc}^2}$$

where t_r = true rise time
 t_{tot} = measured rise time
 t_{osc} = oscilloscope rise time
 (5.8 ns for HM 605)

If t_{tot} is greater than 50 ns, this can be taken as the rise time of the pulse, and further calculation is unnecessary. Thus, the true rise time from Example 2 would actually be

$$t_r = \sqrt{32^2 - 5.8^2} = 31.46 \mu\text{s}$$

Extra features of the HAMEG HM 605

CRT beam modulation

The HAMEG HM605 has the added facility of beam (Z) modulation. This enables the trace to be switched from light to dark, depending on the applied modulation signal. One example of Z-modulation is to display time markers on the trace, which are fed from an external source. The intensity of the beam cannot be varied. It can only be switched on or off.

A square wave modulation signal should have a maximum level of 5V_{pp} (TTL signals) and is applied directly to the BNC socket marked Z, located on the rear side of the instrument. This gives a connection via an RC-network to grid 1 of the CRT. The effect of a positive logic signal will cause the beam to be switched on. The Z input signal should be supplied from a source which has an output impedance lower than 600 Ω . A signal generator which produces negative signals relative to ground is unsuitable. A DC offset voltage should not be connected to the Z input socket.

When using the Z-modulation facility to display calibrated time markers, the modulation generator must be able to be synchronized or have a fine frequency control. In this case, to produce fixed trace time markers, it is of advantage to apply a modulation frequency, which is a multiple of the signal frequency, i.e. for a signal frequency of 1 kHz, the Z-frequency should be 5 or 10 kHz or more.

The Z-modulation can also be controlled via a switch (manual or relay). This requires no voltage source. The switch contact is connected across the Z-input. When the contact is closed, the beam will be dark (off), when the contact is open, the beam will be bright (on).

Timebase signal output

A BNC socket located on the rear side of the oscilloscope (labelled with a sawtooth waveform) can be used to obtain a sample signal from the oscilloscope's internal timebase. The waveform output is approx. $5V_{pp}$ and varies in frequency depending on the setting of the timebase switch.

The connected load to this socket should always be above $10k\Omega$. A capacitor should be connected in series if the DC-content of the signal is not required.

Y output

The Y deflection signal, which is applied to the CRT's Y-plates, is available at the BNC socket marked "Y", located at the rear of the oscilloscope.

The Y-output will be the same signal as displayed on the CRT screen with a level of approximately $100mV_{pp}$ (open circuit) for an amplitude of 1 cm shown on the CRT screen.

The output is DC-coupled and is approx. at ground potential. The bandwidth corresponds to that of the instrument, but is strongly dependent on the capacitive load. Normally, an Y output cable should be terminated by 50Ω . The output voltage is then reduced to $50mV_{pp}/cm$.

The Y-output is independent of the Y POS and X POS controls, as well as the INVERT mode. It can be switched, using the I/II trigger pushbutton, to Channel I or II.

Graticule illumination

The HAMEG HM605 has an illuminated internal graticule, which can be used when trace photographs are required. The illumination is adjustable for two intensities. At position 0, the graticule lamp is switched off. Settings 1 or 2 should be selected in accordance with type of film and camera used.

Component Tester

General

The HAMEG HM605 has a built-in electronic component tester, which is used for an instant display of a test pattern to indicate whether components are in working condition. The component tester can be used to easily check resistors, capacitors, inductors, diodes and transistors. A limited number of tests can be made on integrated circuits. All components can be tested in and out of circuit, but in all cases no other signals or voltages should be connected to the component under test. The component tester uses a test voltage of $8.5V_{rms}$.

Controls and setting up

The component tester is switched on by depressing the COMPONENT TESTER pushbutton switch on front panel. Two test leads with banana plug connectors and test prods are required. These are connected to the component tester Input/Output socket and an oscilloscope ground socket on front panel.

When the component tester is switched on, the only oscilloscope controls which can be operated, are INTENS., FOCUS, X POS., X MAGN $\times 10$.

To return the oscilloscope to normal operation, release the COMPONENT TESTER pushbutton switch.

Typical test procedure

– CAUTION –

Do not test any component in live circuitry – remove all grounds, power and signals connected to the component under test.

Set up component tester as stated above. Connect test leads across component to be tested. Observe oscilloscope display.

Test pattern displays

The typical test pattern displayed by various components under test are shown on page M 20.

- open circuit is indicated by a straight horizontal line.
- short circuit is shown by a straight vertical line.

Testing resistors

The test pattern expected from a resistor is a long straight line. The angle of slope is determined by the value of the resistor under test. With high values of resistance, the slope will tend towards the horizontal axis and with low values, the slope will move towards the vertical axis.

The values of resistors from 20 Ohm to $4.7k\Omega$ can be approximately evaluated. The determination of actual values will come with experience, or by direct comparison with a component of known value.

Testing capacitors and inductors

The test pattern from capacitors and inductors should be an ellipse. The width of the ellipse will vary according to the value of the component under test. Test patterns of capacitors with values in the ranges from 0.1 μF to 1000 μF can be displayed and approximate values obtained. Precise measurement can be obtained by comparing the component under test with a component of known value. Inductive components (coils, transformer) will display an inclined ellipse (see fig. on page 20). This is due to the resistance of the winding.

Testing semiconductors

Most semiconductor devices, such as diodes, zener diodes, transistors, FETs can be tested. The test pattern displays vary according to the component as shown in fig. on page 20.

The main characteristic displayed during semiconductor testing is the voltage dependent knee caused by the junction changing from the conduction state to the non-conduction state.

Transistors and diodes

Different tests can be made to diodes and transistors, base-emitter, base-collector and emitter-collector. The resulting test patterns are shown in fig. on page 20. These tests are non-destructive and give an instant indication of whether a diode or transistor is faulty. Diodes and transistor junctions with a breakdown voltage, which is higher than the test voltage ($12V_p$), may not display a true characteristic (found with high voltage diodes and zener diodes with a zener point above 12V). It will normally be found that a defective semiconductor under test will give a totally different display as compared to a display of a working component of the same type.

The advantage of these tests is found to be that instant information is given, to see if the component is defective on account of a short or open circuit.

– CAUTION –

When testing MOS components, care should be taken to discharge residual or static charges, which may be present in the component. Hum may also be displayed when tests are made on transistors – this may be due to inputs not being grounded.

In-circuit tests

– CAUTION –

Remove all ground connections, signals and voltages from circuit under test.

Testing components connected in a circuit can be achieved, but in some cases the results are not conclusive. Components, which are connected to other circuit elements, change the characteristic of the component and will give a different pattern from the one normally expected.

By comparing the test pattern of the circuit under test to that of an operating circuit, a defect can easily be determined. Using the test prods, identical tests positions in each circuit can be checked and the resulting test displays compared.

Summary of operating instructions

– CAUTION –

This summary is not intended for first time operation. The operating instructions must be read before operating oscilloscope.

1) Applying power

- Check for correct mains/line power setting on rear panel of oscilloscope.
- Connect instrument using 3-pin receptacle to mains/line power.
- Place oscilloscope in correct operating position.
- Set all controls to calibrated or normal operation.
- Depress POWER on/off pushbutton switch. Yellow indicator LED will illuminate.
- Adjust CRT intensity and focus.

2) Y-axis mode selection

- CHANNEL I TRACE:
Release all Y-mode and timebase pushbutton switches.
- CHANNEL II TRACE:
Depress CH I/II and TRIG I/II pushbutton switches.
- DUAL TRACE CHANNEL I AND II:
Depress DUAL pushbutton switch.
Release or depress TRIG I/II switch.

DUAL mode can be operated in alternate mode (signals >1 kHz) with ALT/CHOP button released, or in CHOP mode, with ALT/CHOP pushbutton depressed.

- ADD CHANNEL I+II:
Depress only I+II (ALT/CHOP) pushbutton switch.
- DIFFERENCE OF CHANNEL I AND II:
Depress pushbutton switches I+II (ALT/CHOP) and INVERT I.
- Differential Measurements:
Depress INVERT I and ALT/CHOP pushbuttons.
Connect signal to Y I and Y II inputs without ground connections.
- X-Y OPERATION:
Depress X-Y pushbutton switch. Connect X-signal to HOR INP (CH II). Ensure INTENS is turned down.

3) Application of signal

- Calibrate probe if necessary
- Select input coupling on channel input switch DC-AC-(GD).
- Adjust Y-amplitude switch to display signal at required height.
- Note OVERSCAN indicators.
- Trigger oscilloscope on PEAK mode or NORMAL as required. Adjust Trigger LEVEL.

- Adjust TIMEBASE switch to display required signal.
- When making amplitude or frequency measurements, set all amplitude and timebase fine-controls to C (calibrated) and push the X MAGN x10 switch.
- To trigger TV frame frequency signals, select LF trigger coupling.
- To trigger digital words or pulse trains use HOLD OFF control.

4) Timebase and triggering

- Select timebase speed to display required signal.
- Select trigger mode PEAK or NORMAL.
- Trigger signal according to Y-axis mode, pushbutton I/II for Channel I or II or for Dual alternate trigger mode, push ALT. button.
- External Trigger signal is connected to EXT TRIG input socket with EXT switch depressed.
- Trigger level is adjusted by LEVEL control.
- Trigger slope selected with SLOPE +/- pushbutton switch.
- Trigger coupling selected by AC-DC-HF-LF switch.
- Set AC or DC up to 1 MHz, HF above 1 MHz, LF below 1 kHz. For Video line signal set to AC or DC, for video frame signal set to LF.
- Trigger indicator will illuminate when timebase is triggered.
- For single sweep operation depress SINGLE pushbutton; reset by pushing RESET pushbutton.

Use of sweep delay – Modes

Norm: Sweep delay off.

Oscilloscope in normal operation.

Search: Delay time switches (coarse and fine) are used to select delay time of sweep or point of interest. Delay Mode LED flashes.

Delay: Delayed trace now displayed. Signal expansion obtained by increasing timebase speed. LED illuminates.

5) Component tester

- Connect test leads to component tester socket and one of the two ground sockets.
- Depress component tester pushbutton switch.
- Disconnect all power, ground connections, and signals from circuit under test when testing components in-circuit.

Test patterns

Single Components

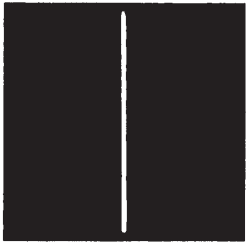

Short circuit

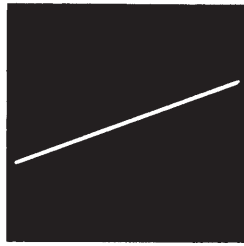

Resistor 510 Ω

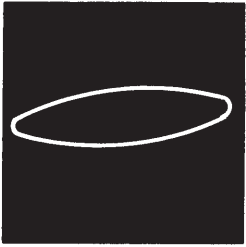

Mains transformer prim.

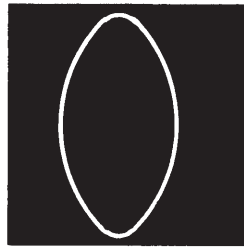

Capacitor 33 μF

Single Transistors



Junction B-C



Junction B-E



Junction E-C



FET

Single Diodes

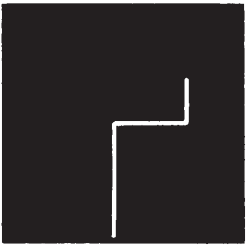

Z-diode under 8V



Z-diode beyond 12V



Silicon diode



Germanium diode



Diode paralleled by 680 Ω



2 Diodes antiparallel



Diode in series with 51 Ω



B-E paralleled by 680 Ω

In-circuit Semiconductors



Rectifier



Thyristor G + A together



B-E with 1 μF + 680 Ω



Si-diode with 10 μF

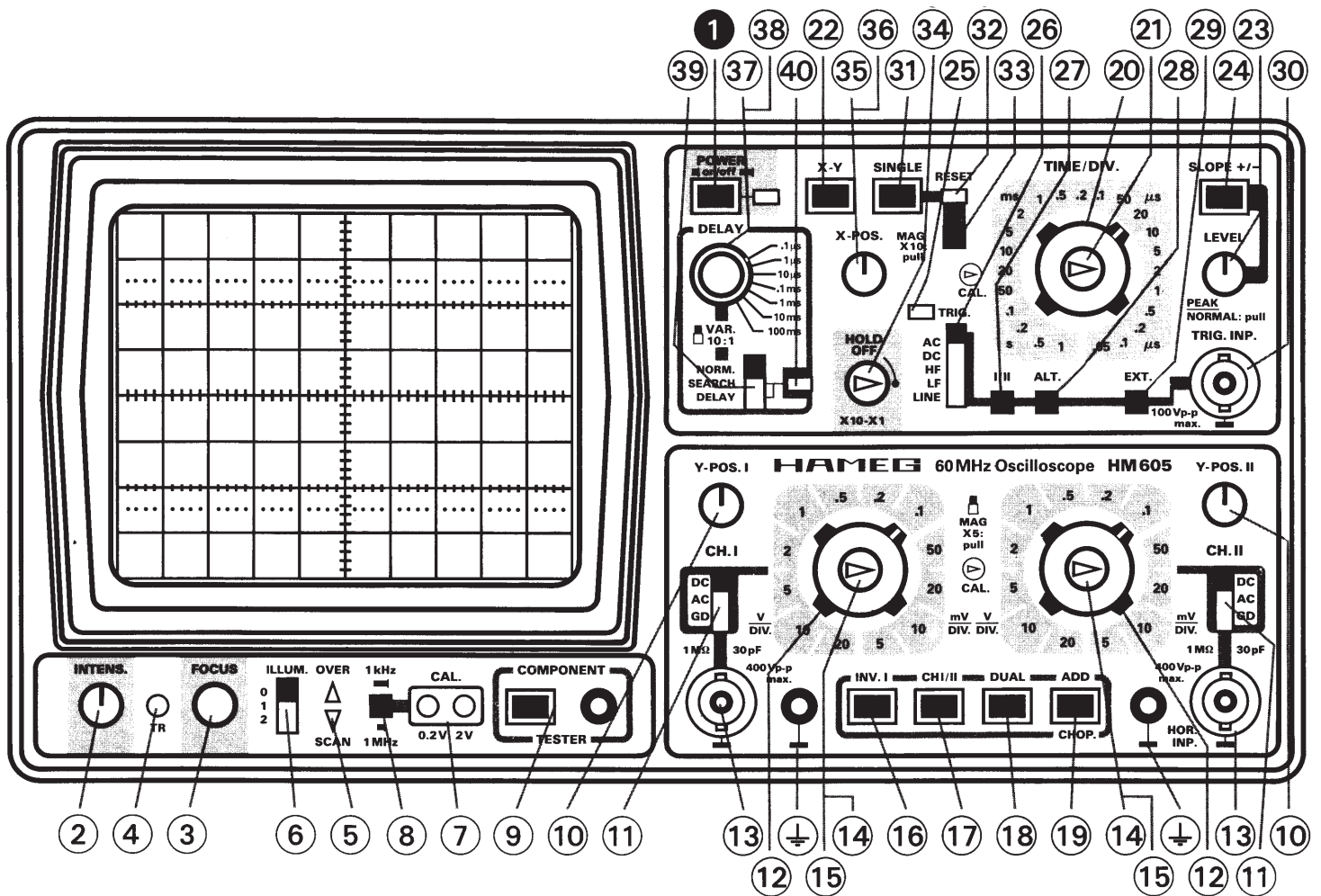

Controls located underneath the instrument

- ④ **DC BALANCE** To adjust DC balance of the vertical (Y) preamplifiers.

Elements located on rear panel of instrument

- ④ **APPLIANCE INLET** Use only 3-pin power cord supplied with instrument to connect to line supply.
- ④ **LINE VOLTAGE SELECTOR** Holds fuse and selects supply voltage.

- ④ **BNC SOCKETS - OUTPUT** Output for timebase ramp signal.
- ④ **Z - INPUT** Input for trace modulation signal (Z-modulation).
- ④ **Y - OUTPUT** Signal output of Channel I or II.

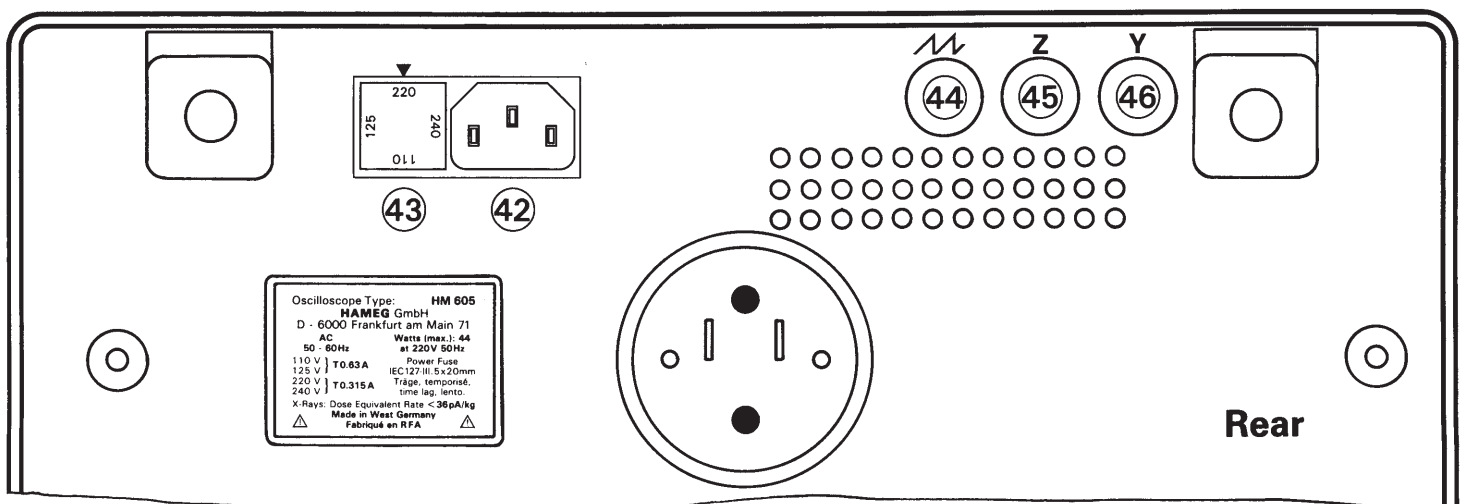

Front Panel Elements

The HAMEG HM605 front panel is divided into sections according to the various oscilloscope functions.

The following table gives a short description of each front panel element. (See Fig. 20 – View of Front Panel).

Front Panel Element	Function	Front Panel Element	Function
① Power ON/OFF (pushbutton switch) and power LED	Line master switch Power ON is indicated by illuminated LED.	⑳ TIMEBASE (rotary switch)	Timebase selector switch (1 s/cm to 0.05 μ s/cm).
② INTENS control	Intensity control for adjustment of CRT display brightness.	㉑ TIMEBASE (center pot.)	Timebase variable control for fine adjustment. This control should normally be reset to the C (calibrated) position.
③ FOCUS control	Control to adjust display focus (sharpness).	㉒ X-Y (pushbutton switch)	Selects X-Y operation. Switches off the internal timebase generator and connects channel II (HOR. INP.) to the X-amplifier.
④ TR (Trimmer Pot.)	Trace Rotation – used to correct trace angle.	㉓ LEVEL- PEAK/NORMAL (push-pull switch)	Control for adjusting trigger level. Push for automatic peak value triggering.
⑤ OVERSCAN (LED Indicators)	Direction Indicators – will illuminate when trace passes vertical screen limits.	㉔ SLOPE +/- (pushbutton switch)	Switch to select triggering on positive- or negative-going edge of signal.
⑥ ILLUM – 0, 1, 2 (3-position slide switch)	Controls graticule illumination. Off, Dim, Bright	㉕ TRIG. (LED indicator)	Trigger lamp to indicate when timebase is triggered.
⑦ CAL 2V, 0.2V (Test sockets)	Calibrator square-wave signal source.	㉖ TRIG. AC/DC/HF/LF/Line (slide switch)	Selects trigger coupling (AC, DC, HF, LF). Set to LINE for line triggering.
⑧ CAL 1 kHz/1 MHz (pushbutton switch)	Selects calibrator frequency 1 kHz or 1 MHz.	㉗ TRIG. I/II (pushbutton switch)	Selects trigger signal from Channel I or Channel II.
⑨ COMPONENT TESTER (pushbutton switch and single pole socket)	Switch to convert oscilloscope to component tester mode. Connector for single test lead. Second test lead is connected to chassis ground socket.	㉘ ALT	Selects alternate trigger mode from Channel I and Channel II.
⑩ Y POSI, Y POS II (Control pot.)	Adjusts vertical position of trace for Channel I and Channel II.	㉙ EXT. (pushbutton)	Selects external trigger mode.
⑪ CH. I, DC, AC, GD CH. II, DC, AC, GD (3-position slide switch)	Input coupling selector switch for each channel. DC – direct connection, AC – via capacitor, GD – input grounded (signal disconnected).	㉚ EXT. TRIG. (BNC connector)	Input for external trigger source.
⑫ Y-AMPL. I/II Amplitude control (Multi-position rotary switch)	Selects the Y amplifier gain and indicates the scale factor of vertical display in V/cm and mV/cm.	㉛ SINGLE (pushbutton)	Selects single sweep operation.
⑬ CH I (II) BNC sockets and supplementary ground sockets	Signal input for Channel I (left) and Channel II or horizontal X-input (right). Input impedance: 1 M Ω II 28 pF.	㉜ READY (LED indicator)	Ready lamp to indicate that oscilloscope is armed for single sweep operation.
⑭ Amplitude variable control (Center Pot.)	For fine adjustment of vertical amplitude. Should normally be reset to C position. Decreases Y sensitivity when turning counter- clockwise.	㉝ RESET (pushbutton switch)	Press to reset.
⑮ MAG x5 (push-pull switch)	Increases Y sensitivity by a factor of 5.	㉞ HOLD OFF (Pot.)	Fine adjustment of time interval between timebase sweeps.
⑯ INVERT I (pushbutton switch)	Inverts display on Channel I	㉟ X-POS. (Control Pots.)	Adjusts horizontal position of trace. (Coarse and fine).
⑰ CH I/II (pushbutton switch)	Selects channel to be displayed in MONO mode.	㊱ X MAGN. x10 (push-pull switch)	Trace magnifier – expands the X-axis by a factor of 10.
⑱ DUAL (pushbutton switch)	Selects single (MONO) or dual trace operation.	㊲ DELAY (8 position rotary switch)	Coarse adjustment of sweep delay time. Operative only during SEARCH and DELAY modes.
㉑ ALT/CHOP I/II (pushbutton switch)	Selects alternate or chopped display in DUAL mode. In MONO mode, displays the sum of two signals. (DUAL switch has to be released).	㊳ DELAY (Center pot.)	20 turn helical pot. for fine adjustment of sweep delay time.
		㊴ DELAY – NORM, SEARCH, DELAY (3 position slide switch)	Selector switch for delay mode operation.
		㊵ DELAY (LED indicator)	Lamp will flash in SEARCH mode and is permanently illuminated in DELAY mode.

HAMEG

Oscilloscopes

Multimeters

Counter Timers

Power Supplies

Calibrators

**Signal
Generators**

**Check Point
Testers**

Distributed by:

West Germany

HAMEG GmbH

Kelsterbacher Str. 15-19

6000 FRANKFURT am Main 71

Tel. (069) 67.60.17 · Telex 4.13.866

France

HAMEG S.a.r.l.

5-9, av. de la République

94800-VILLEJUIF

Tél. (1) 46.77.81.51 · Télex 270.705

Spain

HAMEG S.A.

Villarroel 172-174

08036 BARCELONA

Teléf. (93) 230.15.97

Great Britain

HAMEG LTD

74-78 Collingdon Street

LUTON, Bedfordshire LU1 1RX

Tel. (0582) 41.31.74 · Telex 825.484

United States of America

HAMEG, Inc.

88-90 Harbor Road

PORT WASHINGTON, New York 11050

Phone (516) 883.3837 · TWX (510) 223.0889